

32" LCD TV
QUICK SETUP GUIDE
 DX-32L100A11



Remote control and 2 AAA batteries



AC power cord



TV stand and screws

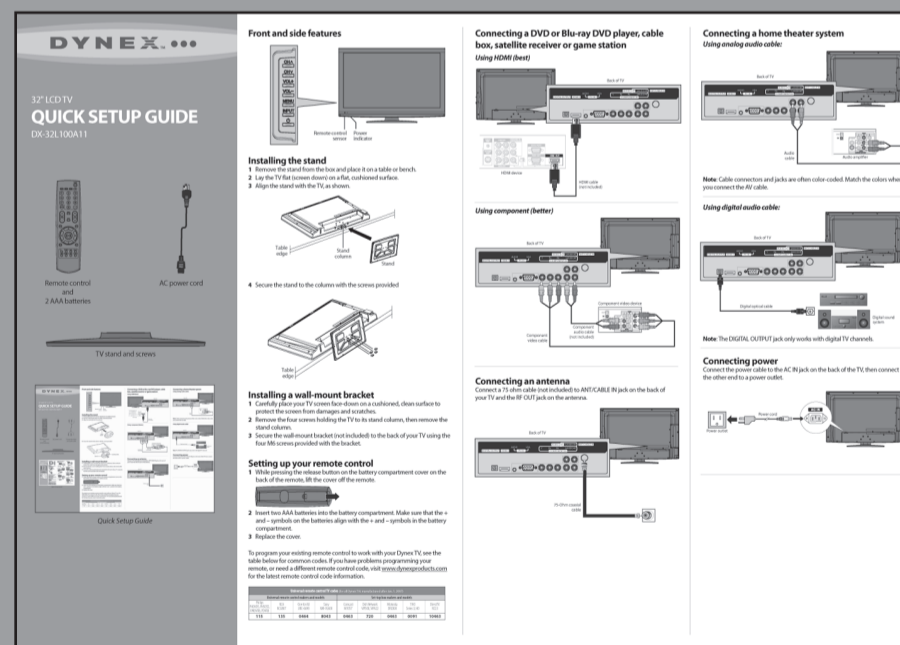

Quick Setup Guide

Front and side features

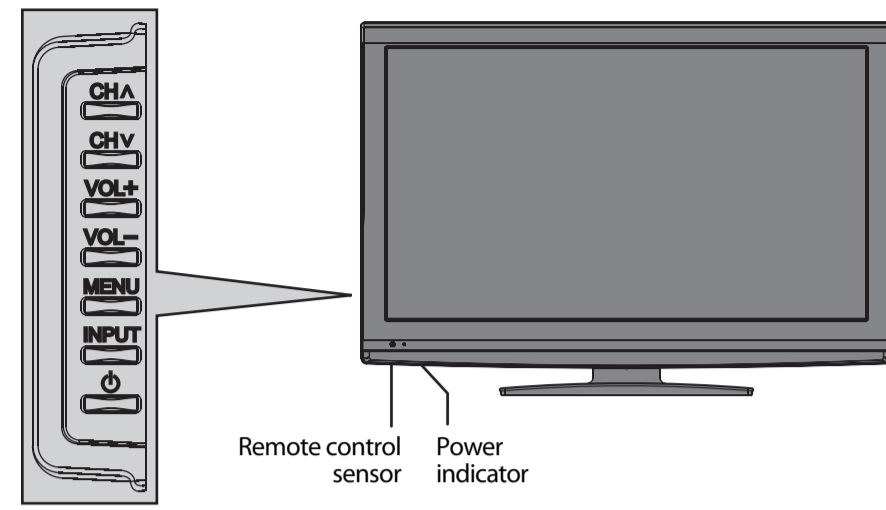

Installing the stand

- 1 Remove the stand from the box and place it on a table or bench.
- 2 Lay the TV flat (screen down) on a flat, cushioned surface.
- 3 Align the stand with the TV, as shown.

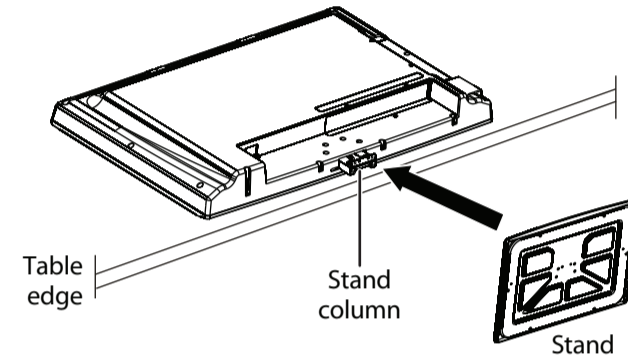

- 4 Secure the stand to the column with the screws provided

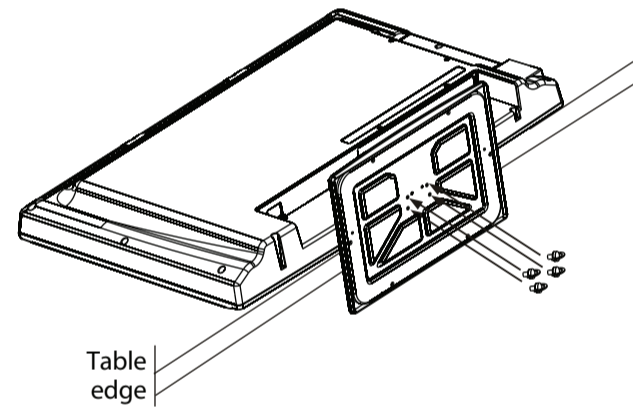

Installing a wall-mount bracket

- 1 Carefully place your TV screen face-down on a cushioned, clean surface to protect the screen from damages and scratches.
- 2 Remove the four screws holding the TV to its stand column, then remove the stand column.
- 3 Secure the wall-mount bracket (not included) to the back of your TV using the four M6 screws provided with the bracket.

Setting up your remote control

- 1 While pressing the release button on the battery compartment cover on the back of the remote, lift the cover off the remote.

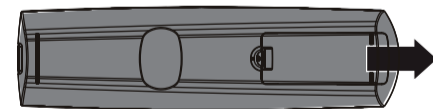

- 2 Insert two AAA batteries into the battery compartment. Make sure that the + and - symbols on the batteries align with the + and - symbols in the battery compartment.
- 3 Replace the cover.

To program your existing remote control to work with your Dynex TV, see the table below for common codes. If you have problems programming your remote, or need a different remote control code, visit www.dynexproducts.com for the latest remote control code information.

Universal remote control TV codes (for all Dynex TVs manufactured after Jan. 1, 2007)									
Universal remote control makers and models					Set-top box makers and models				
Philips PHD05, PHD55, PMD05B, PMD55B	RCA RCU807	One for All URC-6690	Sony RM-VL600	Comcast M1057	Dish Network VIP508, VIP622	Motorola DRC800	TIVO Series 3, HD	DirectTV RC23	
115	135	0464	8043	0463	720	0463	0091	10463	

Connecting a DVD or Blu-ray DVD player, cable box, satellite receiver or game station

Using HDMI (best)

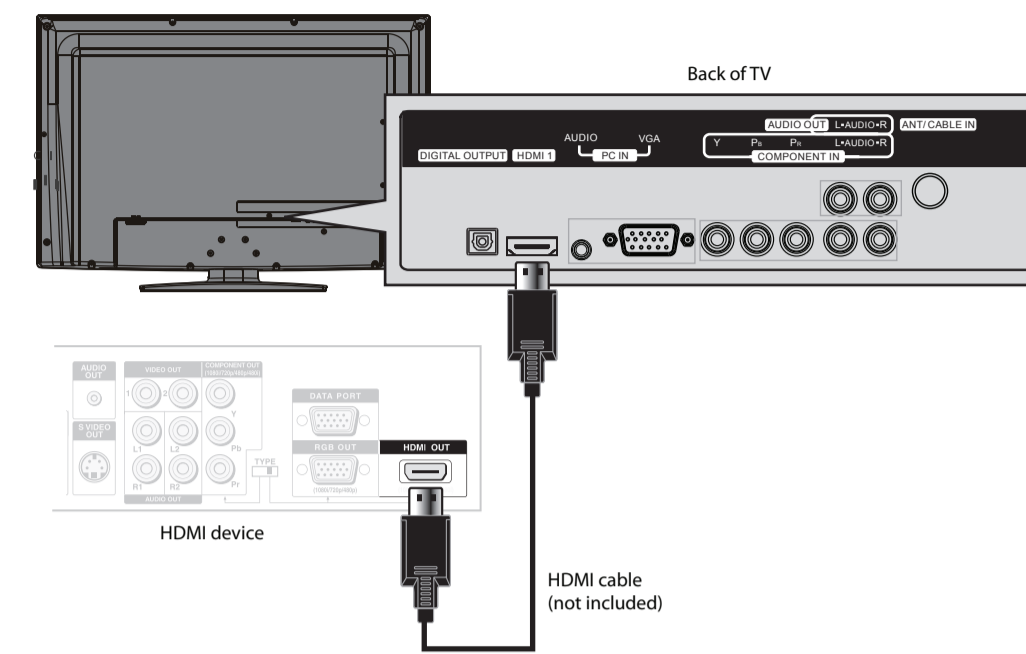

Using component (better)

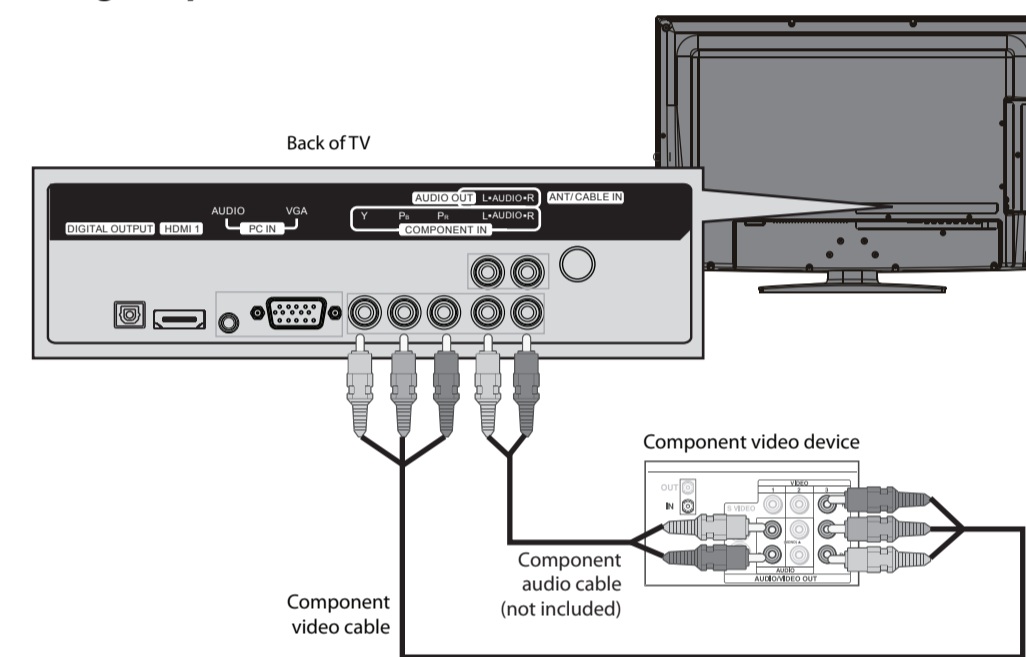

Connecting an antenna

Connect a 75 ohm cable (not included) to ANT/CABLE IN jack on the back of your TV and the RF OUT jack on the antenna.

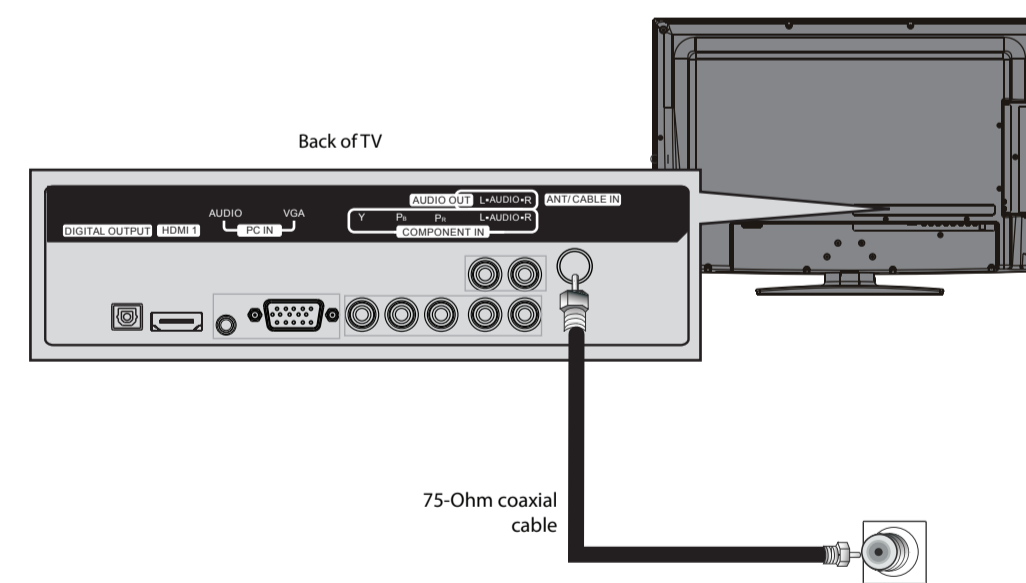

Connecting a home theater system

Using analog audio cable:

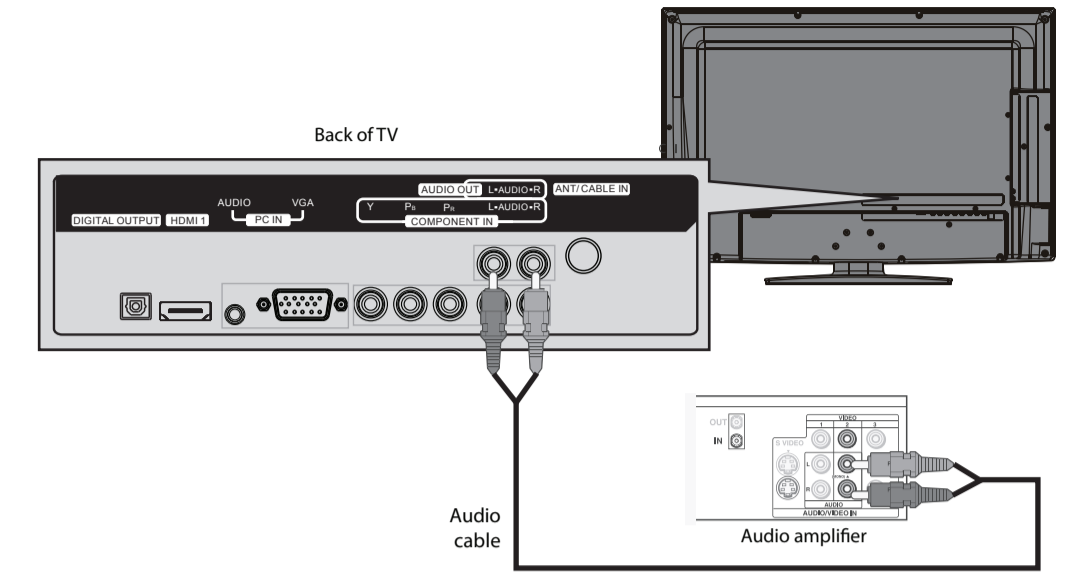

Note: Cable connectors and jacks are often color-coded. Match the colors when you connect the AV cable.

Using digital audio cable:

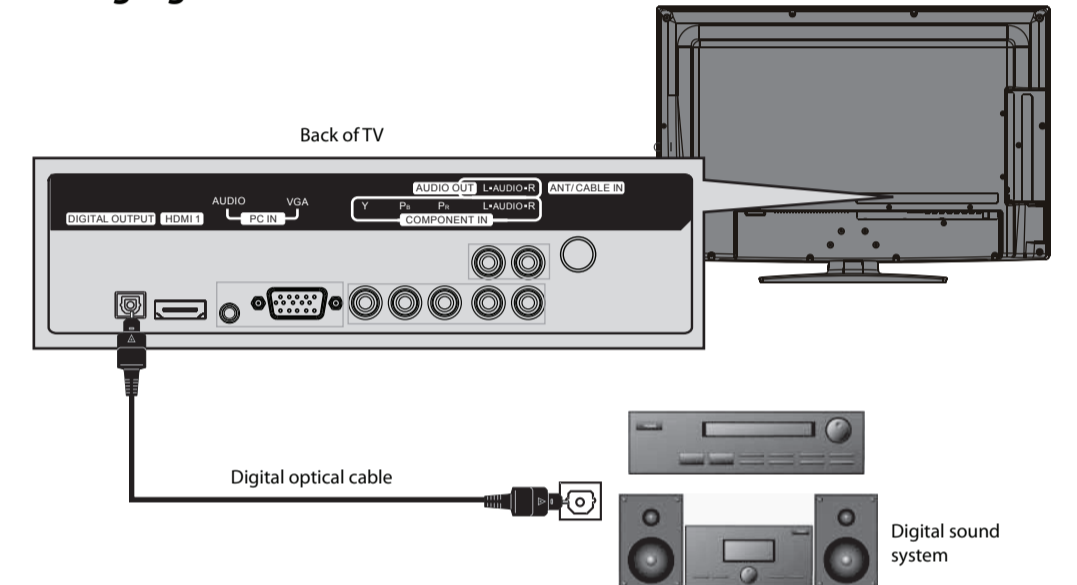

Note: The DIGITAL OUTPUT jack only works with digital TV channels.

Connecting power

Connect the power cable to the AC IN jack on the back of the TV, then connect the other end to a power outlet.

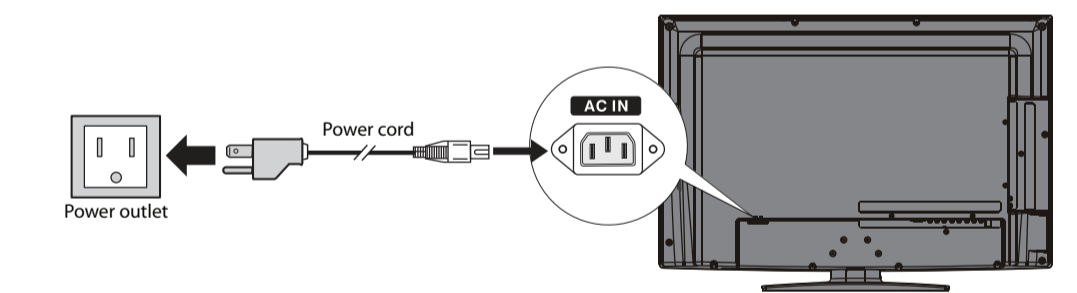

Turning on your TV for the first time

- 1 Plug in your TV and turn it on. The initial *Setup Wizard* opens.



- 2 Press **▲** or **▼** to select the menu language you want, then press **ENTER**. The *Time* screen opens.

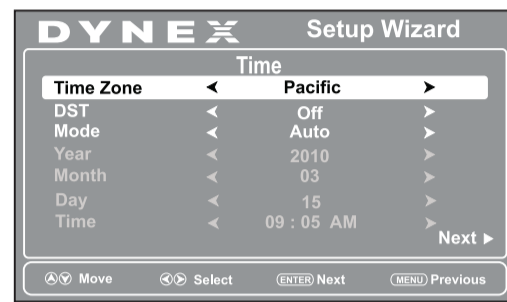

- 3 Press **▲** or **▼** to highlight an option and press **◀** or **▶** to change the setting. Options include:

- Time Zone—Select your time zone
- DST—If your area uses daylight savings time
- Mode—Select Manual to set date/time manually or Auto to have them set automatically.
- If you select Manual, press **▲** or **▼** to highlight an option, then press **◀** or **▶** to change the setting.

- 4 When you are done, press **ENTER** to move to the next screen. The *Choose your Picture Mode* screen opens.

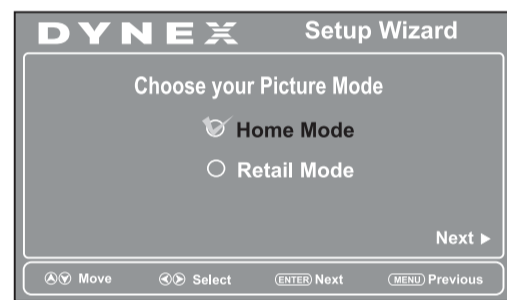

- 5 Press **▲** or **▼** to highlight **Home Mode** (recommended) or **Retail Mode**. If you selected **Home Mode**, the *Choose your TV source* screen opens.

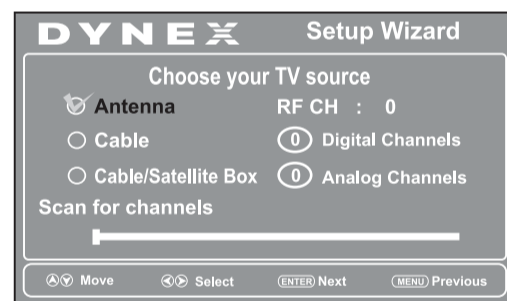

- 6 Press **▲** or **▼** to highlight **Antenna**, **Cable**, or **Cable/Satellite Box**, then press **▶**. If you selected **Antenna** or **Cable**, your TV automatically scans for available channels. If you selected **Cable/Satellite Box**, you are asked to select the correct input source for your set top box. The channel scanning can take up to 30 minutes.
- 7 Press **EXIT** to close the menu, then select the input source through the **INPUT SOURCE** menu.

Selecting the video input source

- 1 Press **INPUT**, press **▲** or **▼** to highlight a source, then press **ENTER**. You can also press any of the video source buttons directly.

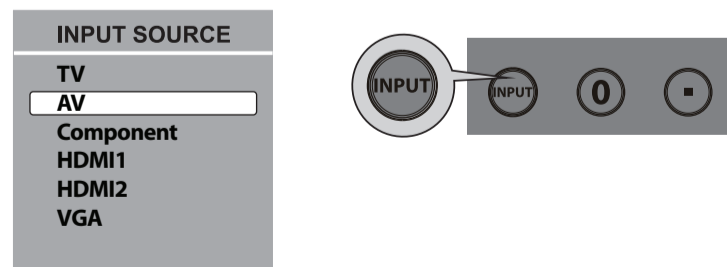

Adjusting the volume

- Press **VOL+** or **VOL-** to change the volume.
- Press **MUTE** to turn off the sound.

Selecting a channel

- To move to a different channel in the channel list, press **CH▲** or **CH▼**. OR
- Enter the channel number directly using the number buttons.

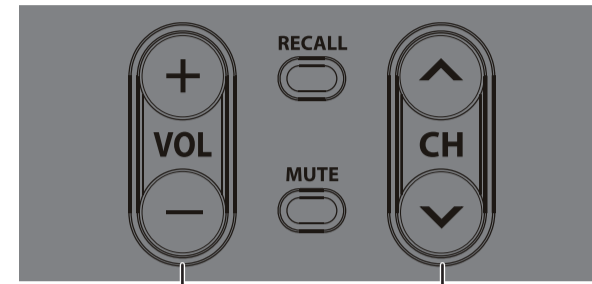

Press to change the volume.

Press to change the channel.

Viewing channel information

- Press **INFO** to view an information banner. The information banner shows the current program information such as channel number, video input source, and resolution.
- Digital mode information—Displays the channel number, station name, channel label, broadcast program name, TV rating, signal type, audio information, resolution, CC mode, current time, and current program start and end times.
- Analog mode information—Displays channel number, channel label (if preset), signal type, audio information, and resolution.
- Press **GUIDE** to show the digital program guide, which may view a list of available programs, program times, and program summaries, depending on the information provided by the broadcaster.

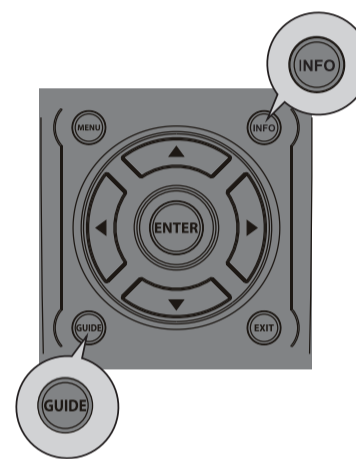

On-screen menu overview

Picture menu

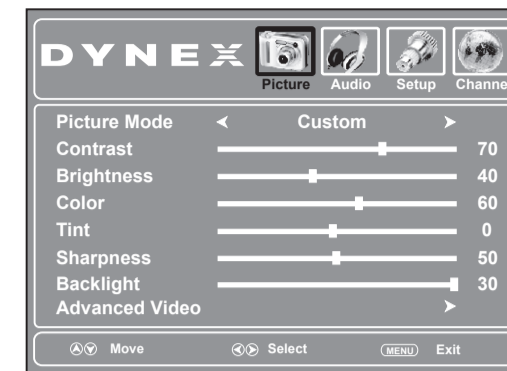

AUDIO menu

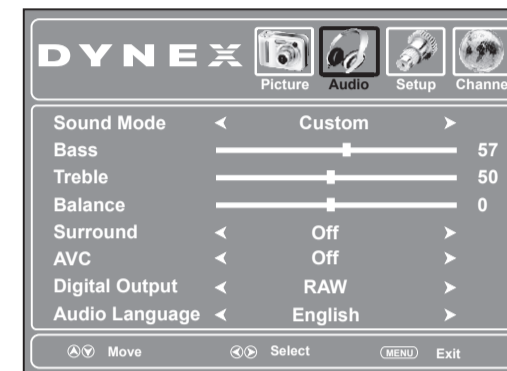

SETUP menu

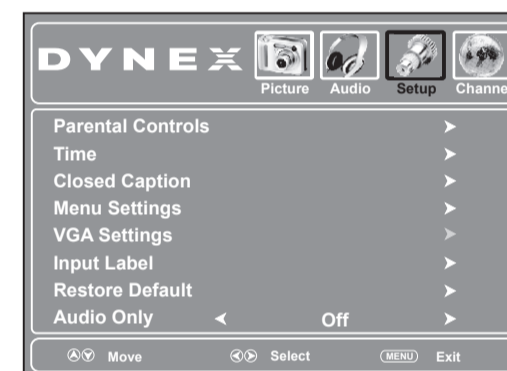

CHANNEL menu

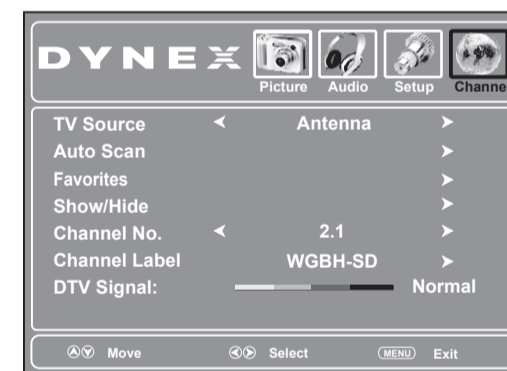

Navigating menus with your remote control

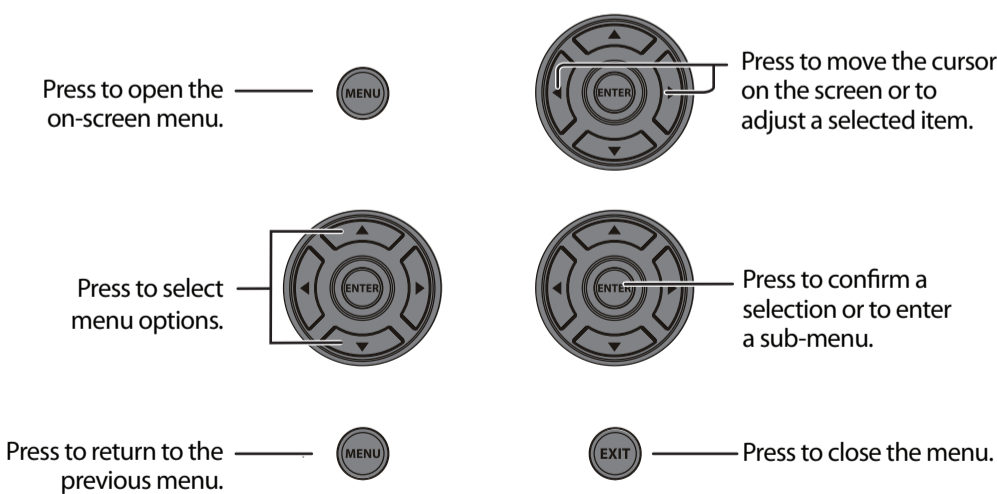

DYNEX™

One-year limited warranty

Visit www.dynexproducts.com for details.

Need additional help?

See your *User Guide*! This comprehensive guide includes everything from basic how-to steps to more advanced features. Your *User Guide* is also available at www.dynexproducts.com.

We're here for you

www.dynexproducts.com

For customer service, call:

800-305-2204 (U.S./Canada markets)

01 800-926-3020 (Mexico market)

Distributed by Best Buy Purchasing, LLC

7601 Penn Avenue South, Richfield, MN USA 55423-3645

Best Buy Imports, S. de R.L. de C.V. Av. Santa Fe 485, Segundo Piso, Colonia Cruz Manca, Programa Parcial de Desarrollo Santa Fe, Delegación Cuajimalpa, Distrito Federal, México 05349

RFC#BBI0802114Q2

© 2010 BBY Solutions, Inc., All Rights Reserved.

DYNEX is a trademark of BBY Solutions, Inc. Registered in some countries. All other products and brand names are trademarks of their respective owners.